



# Mediascreen 4K

## Manual

## Your new Mediascreen

### In the Box:

1. Mediascreen (43" / 55")
2. Remote
3. Power Cable
4. 4 x Screws + Bracket (pre-installed)
5. Set of keys for locking compartment



### Mediascreen

A simple to use display that incorporates a 4K media player with internal HDD to loop video content automatically with power on.

### Remote

Allows navigation of the Android OS.

### Screws and Bracket

4 x screws and a Bracket for installation of the Mediascreen to a wall or flat surface. This comes pre-installed.



## Warranty

Blackbox-av provides a 12 month warranty with this product. For further information or advice please contact [info@blackboxav.co.uk](mailto:info@blackboxav.co.uk)

## Content Installation - Accessing USB Ports

### Lockable Enclosure

The enclosure is located at the bottom of the screen and can be opened / locked with the keys provided.



### USB Inputs

Inside the screen you will find a range of I/O ports including 2 x USB slots. You can use these to upload your content. See Content Upload instructions on page 3.



## Content Installation - Uploading Content

All inputs are located behind a locked compartment on the underside of the unit. To the left of this compartment you will find the power socket and power on / off switch.

The Mediascreen is set-up to automatically loop content upon boot. It will arrive with Demo Content installed (unless you have made your content available to us).

To update with your own content is very simple;

### Install Content on USB

Using a Windows PC, place your desired content (as .mp4 format) onto a USB device.

If you want to play more than one file in order, name your files 01, 02, 03...

With the MediaScreen turned off, insert your USB stick into one of the slots.

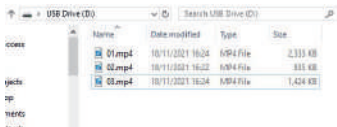

### Importing Content

You will need the supplied remote to navigate the screen OS.

**NOTE:** The screen's IR sensor is located on the left side of the screen.

1) Press **Home** to exit the looping video.



2) Press **Live** to access the Android menu.

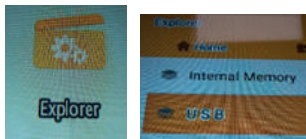

3) Open the Explorer app and select USB.

4) Select the video file you wish to use and long press the **OK** button until an options menu pops up.

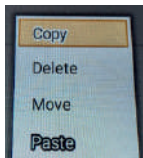

5) Select **Copy**

6) Return to the 'Home' panel and enter the 'Content' folder.

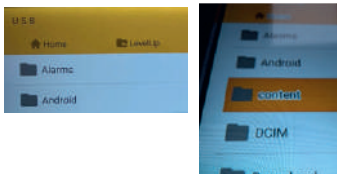

## Importing Content (cont.)

7) Select 'Editor' from the top menu and then select 'Paste' to copy your file.

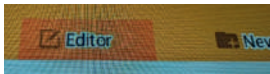

8) Repeat until all files required have been copied from USB.

9) Delete files from the 'Content' folder that you no longer need. Long press **OK** on the file and select 'Delete'.

10) Return to the Android Menu (**Home** and then **Live** on the remote)

11) Select 'Fully Video Kiosk'

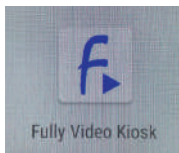

12) Your content should automatically play. If it does not simply power off / on the screen.

## Switching Launch Device

The MediaScreen will automatically play content from the onboard HDD. You are able to utilise external media players via the HDMI input and the onboard 'HDMI-IN' application.

To launch into and use an external media player via this app you will need to do the following;

### Switching to HDMI-IN.

- 1) Connect a mouse via USB
- 2) Connect your device via HDMI
- 3) Swipe Left > Right and choose 'Exit Fully Video' to escape the looping media

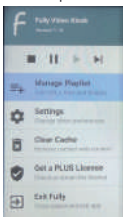

- 4) Swipe up from the bottom of the screen to access the app menu

- 5) Select AutoStart Manager

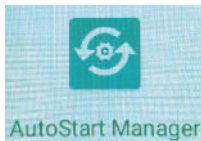

- 6) Select 'Add to AutoStart'

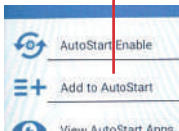

- 7) Tick 'HDMI-IN' from the list and select 'Save'.

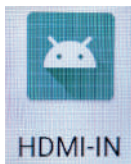

- 8) Press back then 'View AutoStart Apps'

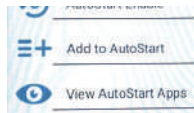

- 9) Delete 'Fully Video Kiosk' from the list, leaving only 'HDMI-IN'

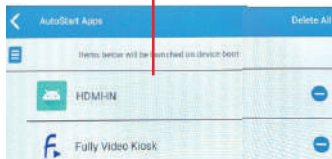

- 10) Right click to exit the app. Manually launch 'HDMI-IN' from the app list to make sure the screen is picking up the signal.

- 11) Power the screen off / on to ensure it boots into HDMI

**NOTE:** Follow these steps but set 'Fully Video Kiosk' to boot into and utilise the internal media player again.

## Technical Information

<b>Panel Size</b>	43" / 55" - 16:19
<b>Dimensions (LxWxH) (mm)</b>	43" – 67.75 x 963.50 x 551.80mm 55" – 67.75 x 1235.70 x 708.20mm
<b>Max Resolution</b>	3840 x 2160
<b>Display Area (mm)</b>	43" – 939.8 x 527.5mm 55" – 1210.1 x 680.5mm
<b>Brightness</b>	300cd/m2 LED
<b>Panel Colours</b>	16.7 M
<b>Contrast Ratio</b>	1800:1
<b>Response Time</b>	4ms
<b>Viewing Angle</b>	178°/178°
<b>Operating System</b>	Android 11
<b>CPU</b>	RK3568K
<b>RAM</b>	2GB
<b>Storage</b>	16GB HDD
<b>Speaker Type</b>	2 x 10W
<b>Power supply</b>	AC 220V
<b>Power Consumption</b>	Maximum - <=180W Standby - <1W
<b>Temperature</b>	(Working Temperature) -10°C~60°C (Storage Temperature) -0°C~40°C
<b>Video Formats</b>	MPEG1 / MPEG2 / MPEG4 / DivX / ASP / WMV / AVI
<b>Audio Formats</b>	WAV / MP3 / WMA / AAC
<b>Image Formats</b>	JPEG / BMP / TIFF / PNG / GIF
<b>Image Resolution</b>	480P/720P/1080P
<b>I/O</b>	1 x RJ45, 2 x USB, 1 x HDMI, 1 x DC in, 1 x TF, 1 x L / R Audio Output
<b>Included</b>	1 x Outdoor Screen, 1 x Wall Bracket (pre-installed), 1 x Power Cable, 1 x Remote Control, 2 x Keys,

# Line Drawings

43" (Drawings not to scale)

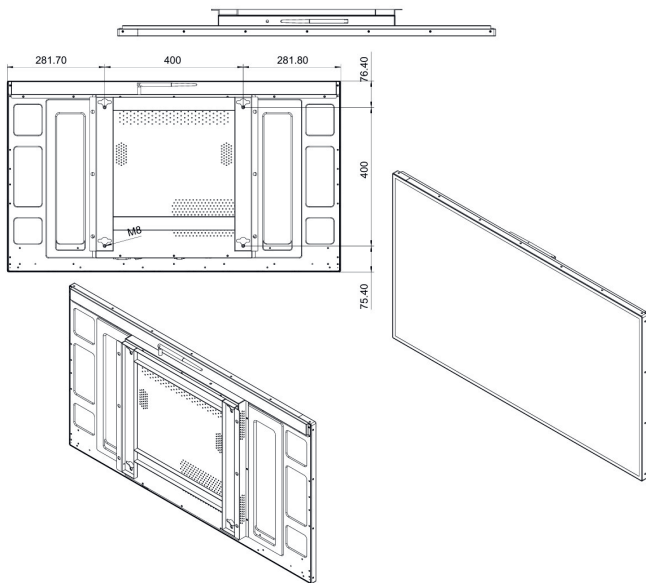
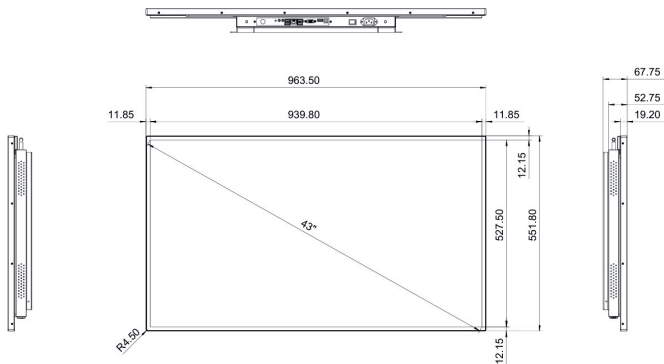



# Line Drawings

55" (Drawings not to scale)

