



Stainless Steel Push Button



- 1 Thread Size**
Purchase as 11mm or 21mm.
- 2 Contact**
The Stainless Steel button is configured for normally open (n/o) operation. If you require a normally closed option, the 21mm offers this.
- 3 Lock Nut**
Easily installed with the provided nut & o-ring.
- 4 SoundClip/VideoClip Configuration**
Use with your own device or alongside our range of media players.

Technical Information

Weight	11mm: 0.0408Kg 21mm: 0.0456Kg
Dimensions	11mm: 21.8W x 21.8D x 27.6H 21mm: 21.8W x 21.8D x 42H
Cable Length	2M
Terminal	Screw and Pin (2.8x0.5)
Max. Switch Rating	11mm: 2A 48VDC 21mm: 1th-5A UI-250VAC
Contact Resistance	≤50mΩ
Insulation Resistance	≥1000m Ω
Dielectric Strength	2000VAC
Operation Temperature	-20°C ~ +55°C
Mechanical Life	1,000,000 Cycles
Electrical Life	11mm: 200,000 Cycles 21mm: 50,000 Cycles
Contact Material	Silver Alloy
Max. Panel Thickness	11mm Thread: 10mm 21mm Thread: 20mm
Torque	5 ~ 14Nm
Operation Pressure	≈4N
Included	1 x Stainless Steel Push Button with Cabling

21mm Thread

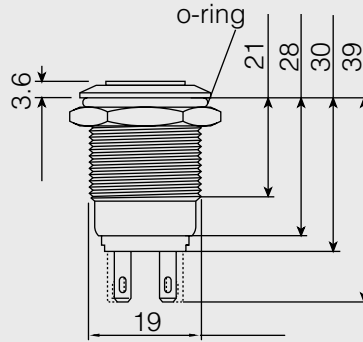

Max. Panel Thickness

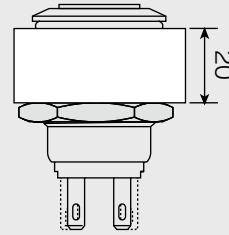

Suggested Panel Cutout

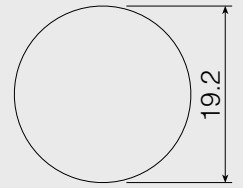

11mm Thread

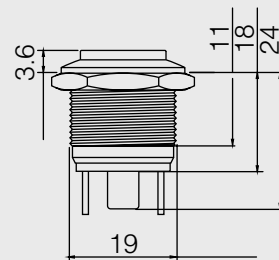

Max. Panel Thickness

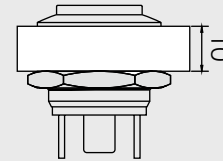

Hex Nut

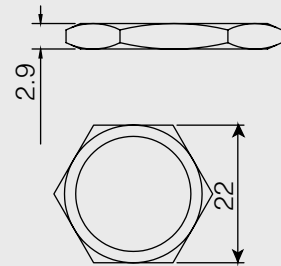

Related Products



16mm Push Button



VideoClip-HD8

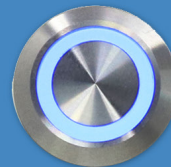

Illuminated Button



SoundClip-2



Email: sales@blackboxav.co.uk
Tel: +44 (0)1639 874100