

## 22" AV Point - Modern

### Manual

## Contents

Safety Guide .....	3
Your new 22" AV Point - Modern .....	4
Setting Up .....	5
Overview.....	5
Formatting.....	6
Programming.....	7
Configuration.....	8
Alternate Programming Commands.....	9
Technical Information.....	10
Technical Drawings.....	10

# Safety Guide

Please observe the following when installing this device.

## Warning

- This product is not designed to be resistant to moisture or excessive dirt/dust. When deciding on a suitable installation point ensure there is reasonable protection from environmental damage.
- If there is damage to the power supply in any way, arrange for a replacement unit by contacting blackbox-av. They may require you to send the defective power unit back so in this case do not dispose of the power supply unless prompted to do so. If you wish to source your own power supply a CE or FC certified double insulated and regulated supply is required.
- Do not place the unit in direct sunlight for prolonged periods as this may cause the product to overheat.
- For disposal of old electrical equipment please follow the guidelines associated with your country/territory or ship the unit back to blackbox-av and we will dispose/recycle the unit. The symbol on the left indicates that this product shall not be treated as household waste. Instead it shall be handed to applicable collection point for the recycling of electronic equipment. If you dispose of this unit correctly you will be helping prevent future harm to the environment which is caused by poor waste management of this type of equipment. If the screen has been damaged make extra care to prevent the LCD liquid from leaking out of the unit and wrap in a strong plastic bag with no holes.



## Precautions of Use

- Whilst the unit is connected to a mains outlet and the power is switched on it is providing energy for operating the device. If the unit is not being used for long periods of time it is recommended to turn off the power as it will prolong the life of its electronic circuitry.

## Your new 22" AV Point - Modern

### In the Box:

1. 22" AV Point – Modern
2. Power Cable
3. 4GB USB
4. Heavy Duty Handsets (optional)

### AV Point

Display button selection and media content via the 22" HD display.

### First Time Setup - Desktop

The unit has a heavy base; the bottom of the unit is supplied with rubber protection to prevent any damage to your surface. We recommend you bolt down the AV Point, you will find a drilling template on our website for fixing the base down to your structure. We also provide long screws to bolt down the stand.

### First Time Setup – Wall Mount

Should you have purchased the Wall Mount version, you will find a bracket pre-attached to the rear of the screen. The bracket has an integrated spirit level and tilt adjustment. Please see the separate manual on how to fit the wall plate and mount the AV Point.

### Customisable Options

You may have handsets or speakers, and a choice between a standard button panel or full graphic button panel.

### Button Configuration

Your 10 buttons are configured by placing content in appropriately named folders. See page 9 for more details

### Powering Up

When you have installed your AV Point you can power up the unit. Supplied is a suitable plug for your country. The unit will power up and begin playing the loaded content. The AV Point has been designed to power on automatically and can be switched off via the mains safely.

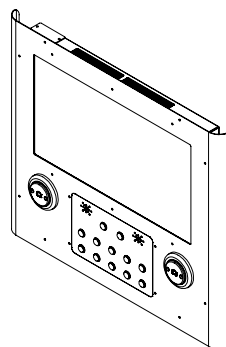
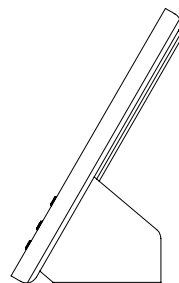

# Setting Up

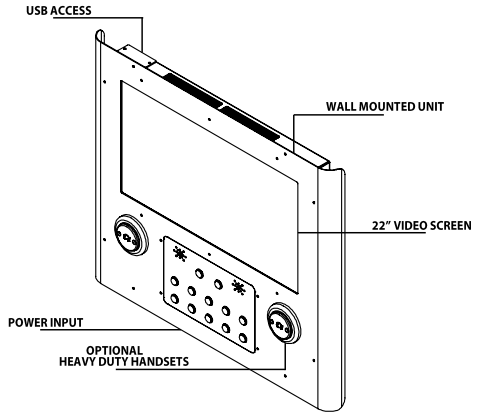
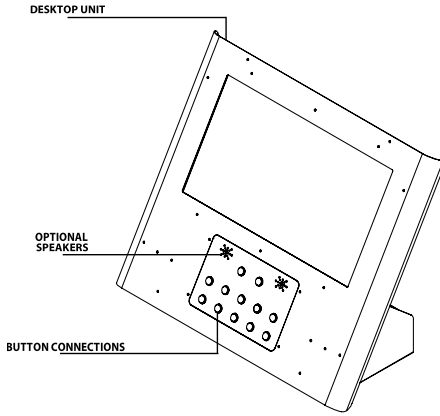

## Overview

### Heavy Duty Handset

If selected as an option, the unit is supplied with up to 2 of our Heavy Duty Handset's. The Handset boasts superb quality speakers, which offers great dynamic range.

### Speakers

If selected as an option, the unit is supplied with two front facing speakers providing great audio quality.

### Button Connections

The unit supports looping or up to 10 buttons and 2 volume buttons if required.

### Power Input

The 22" AV Point - Modern is mains powered at 25W.

### USB Access

A concealed USB socket as located at the top of the unit. This makes an easy access point when content needs changing

## Formatting

### Converting your Content

Before putting the content onto the USB it needs to be in the right format as listed below. Your USB must be formatted to FAT32.

Below displays the file requirements that need to be met for the 22" AV Point - Modern:

Video	Category	Codec/FourCC	Max Res	Max Bitrate
	MP4	MP4	1920x1080 30fps	10M
Photo	Sub Type	Codec	Max Res	Size
	JPG	YUV400 YUV420 YUV422 YUV440 YUV444	1920x1080	No Limit
Audio	Category	Codec	Sample Rate	Bitrate
	MP3	MP3	64-320Khz	32Kbps- 448kbps

#### Image Playback

For optimal image playback we recommend images be 1920x1080 pixels and saved as a JPEG.

#### Audio Playback

For optimal audio playback it is recommended that your audio file is formatted to MP3 and has a bitrate of 44.1Khz.

#### Video Playback

For optimal video playback it is recommended that your video is 1920x1080 pixels and runs at 30 frames per seconds in MP4 format.

# Programming

This section will tell you how to put content onto your device.

There are 12 programmable buttons available within the AV Point. The button panel is designed so that there are two buttons at the top which we program volume control as standard, with space for two front facing speaker and ten main content buttons.

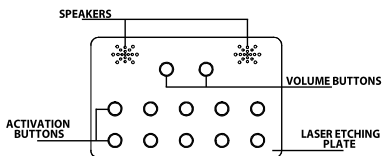

Your unit will be fitted from a choice of the following options:

- 1. In Built Speakers
- 2. Laser Etching Plate
- 3. Customisable Graphic Plate
- 4. Heavy Duty Handset(s)

## 1. Changing Content

In order to change content, we need to access the small cover located on top of the unit. This can be opened using a Pozi Screwdriver, where the USB Stick can then be removed.

We supply a 4GB USB Stick formatted to FAT32

## 2. Windows OS

Windows OS is required to program your AV Point using a PC or laptop (xp – 10).

MacOS is not supported due to hidden files generated by the OS.

## 3. Your Content

Place your files into the folders as seen below.

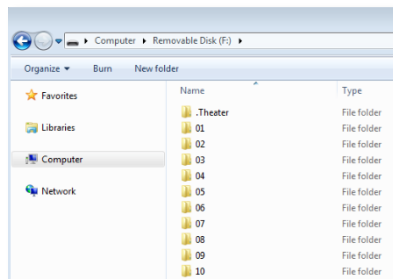

File 01 – Button 1  
File 02 – Button 2  
Etc.

## 4. Loop Files

Any files left in the root of the USB will be played in a loop when button content is not being played.

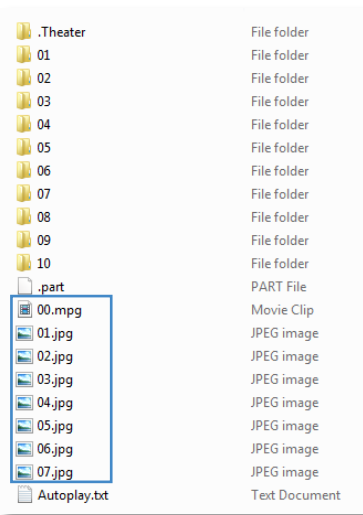

## 5. File Order

You can store up to 99 files within each folder. Should you require more than one file in each button activation folder, you must number your files 01 – 99.

The order in which content plays depends on the media type and name of your file.

The media type is prioritised, so videos are played first, followed by images and lastly audio. This means the file type supersedes the file name.

Below are some scenarios in which the files will be played:

### Order 1

- 004.mp4 (Played first)
- 001.mp3 (Played second)
- 002.mp3 (Played third)
- 003.jpg (Played fourth)

### Order 2

- 001.mp4 (Played first)
- 002.mp4 (Played second)
- 003.mp3 (Played third)
- 004.jpg (Played fourth)

## Configuration

This section is about where you program your buttons as well as other options, such as the default volume levels.

The AV Point associates the top two buttons as volume control and the other 10 with content. Our test content which is pre-loaded has a configuration file called Autoplay.txt



### Button Number

To configure your buttons, you will first need to go into the Autoplay.txt file.

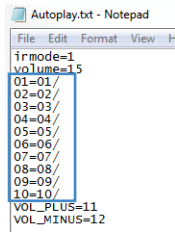

The numbers inside the blue box are associated with your button numbers. The numbers on the left are your buttons (1-10) and the numbers on the right are the folders associated with the button number. We have defined the buttons 01 – 10 with the folders 01 – 10 on the USB Stick. If any of these buttons are pressed the associated folder will open and the AV Point will play the files inside that folder.

### Volume Buttons

Below is a demonstration of the volume buttons:

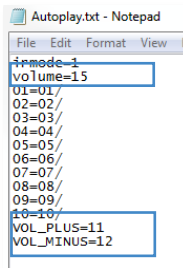

The first box displays your default volume. This will be the volume played upon looping (0-31)

The second box is associated with your volume buttons.

VOLUME\_MINUS and VOLUME\_PLUS are extra commands which are linked with buttons 11 and 12 to control the AV Point's volume.



## Alternate Programming Commands

The AV Point can be configured with additional commands should you wish, these can be included in the Autoplay.txt file.

Command	Example	Description
Vol_plus=	Vol_plus=10	Assigns a button to turn up the volume to a maximum of 31. in the example button 10 will increment the volume.
Vol_minus=	Vol_minus=11	Assigns a button to turn up the volume to a minimum of 0. in the example button 10 will decrement the volume
[vol:--]	01[vol:20]=01	When a button is pressed and a folder content is to be played, The volume can be pre-set. In the example when button 1 is pressed and folder 1 is to be played, the volume is preset to 20.
[n]	20[n]=02	When a button is pressed and a folder content is to be played, The content can be uninterruptable. In the example when button 2 is pressed and folder 2 is to be played, the file or files in that folder cannot be interrupted via another button being pressed.
Mute=	Mute=03	A button can be set to control the AV Point mute command. In the example, button 3 will not mute / unmute the audio
Pause=	Pause=05	Assign a button to pause/un-pause playback. In the example button input 5 will be a pause button.
Next=	Next=07	Skips to the next track (should you have multiple files in a currently selected folder) to be played – In the example key no 7 is assigned to next.
Prev=	Prev=08	Skips to the previous track (should you have multiple files in a currently selected folder) to be played – In the example key no 8 is assigned to Prev.
Stop=	Stop=09	The stop command can be assigned to a button so that playback will return to the beginning of the loop file wherever it may be. If the loop is being played it will start from the beginning. If content is being played inside a folder, playback will stop and return to the beginning of the loop file.

## Technical Information

Weight (Desktop)	15Kg
Weight (Wall Mounted)	15Kg
Dimensions (Desktop)	308.55 x 633.50 x 489.44
Dimensions (Wall Mounted)	51.50 x 635 x 550
Material	Power Coated Steel
Message Storage Medium	USB
Message Encoding Format	.MP3, MP4 or JPG
Power	100-240V 50/60Hz
Power Supply	25W

## Technical Drawings

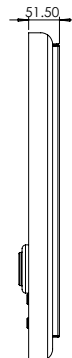
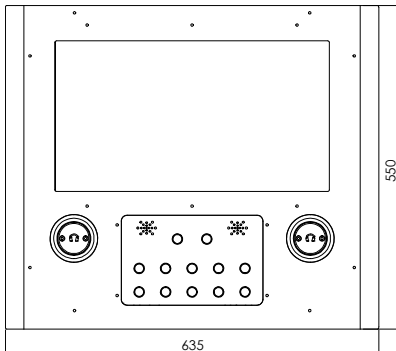
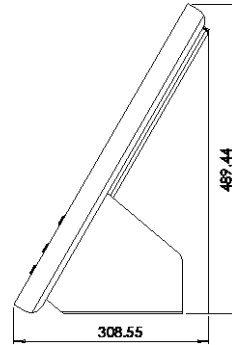
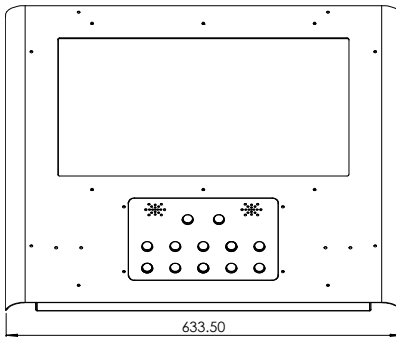

The logo for blackbox-av features a cluster of squares in various shades of blue and black to the left of the text. The text "blackbox-av" is in a bold, lowercase sans-serif font. Below the text, the words "audio", "video", and "interactive" are listed, each preceded by a small blue square.

blackbox-av  
audio video interactive

The logo for the interpretationshop features a stylized blue and black semi-circle to the left of the text. The word "the" is in a small, lowercase sans-serif font, and "interpretationshop" is in a larger, lowercase sans-serif font, with "shop" being bolded.

the  
interpretationshop