

UNLESS OTHERWISE SPECIFIED: DIMENSIONS ARE IN MILLIMETERS SURFACE FINISH: TOLERANCES: LINEAR: ANGULAR:				FINISH: NA		DEBUR AND BREAK SHARP EDGES		DO NOT SCALE DRAWING		REVISION	
								Blackbox-av		01639 767007	
								TITLE:		Single Cup Headphone	
DRAWN				NAME		SIGNATURE		DATE		DWG NO.	
David Knight				DJK		20-2-16				single-cup-headphone	
CHK'D										A3	
APPV'D											
MFG											
Q.A								MATERIAL:		SCALE:1:2	
								NA		SHEET 1 OF 1	
								WEIGHT:			

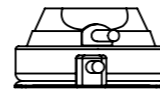

UNLESS OTHERWISE SPECIFIED: DIMENSIONS ARE IN MILLIMETERS SURFACE FINISH: TOLERANCES: LINEAR: ANGULAR:				FINISH: NA		DEBUR AND BREAK SHARP EDGES		DO NOT SCALE DRAWING		REVISION	
								Blackbox-av		01639 767007	
								TITLE: Single Cup Headphone Assem			
DRAWN		NAME		SIGNATURE		DATE					
David Knight		DJK		20-2-16							
CHK'D											
APPV'D											
MFG											
Q.A								MATERIAL: NA		DWG NO. single-cup-headphone-assem	
								WEIGHT:		SCALE:1:5	
								SHEET 1 OF 1		A3	

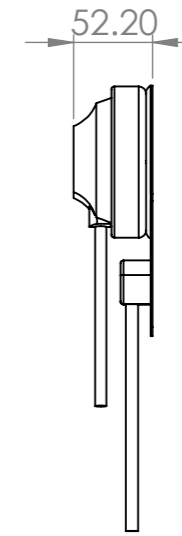
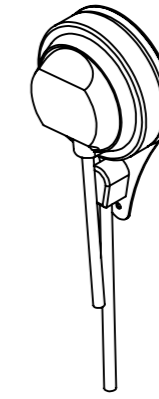
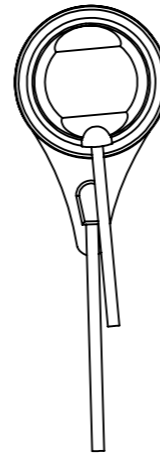
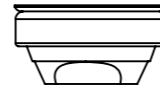
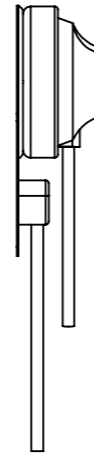
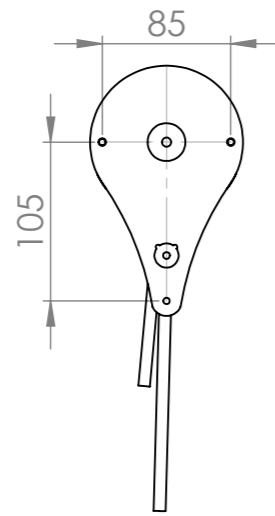
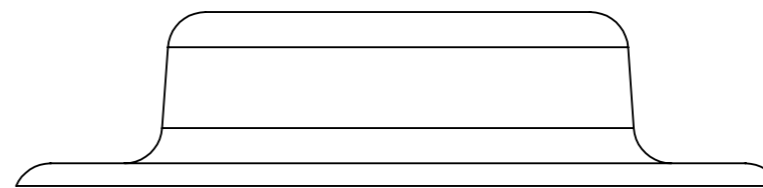
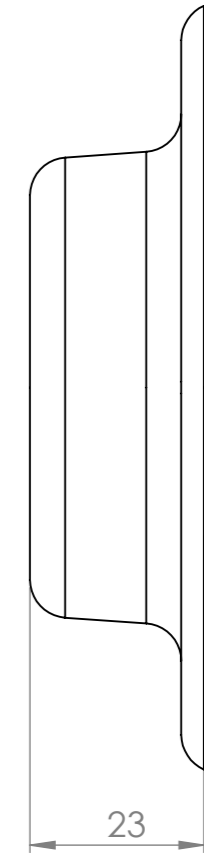
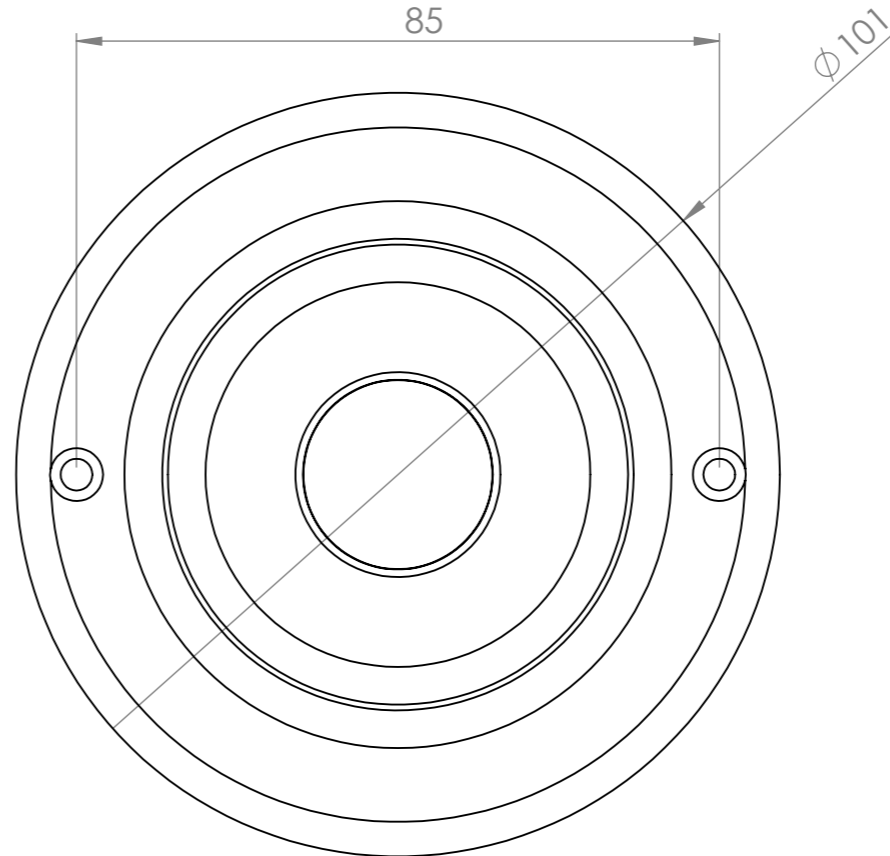
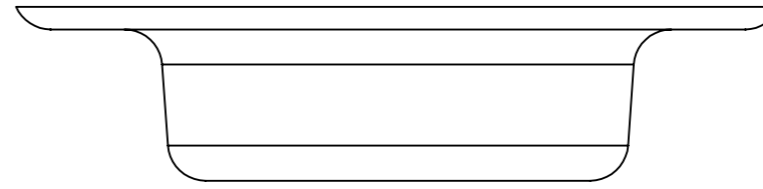
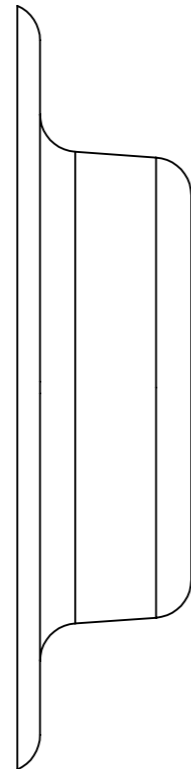
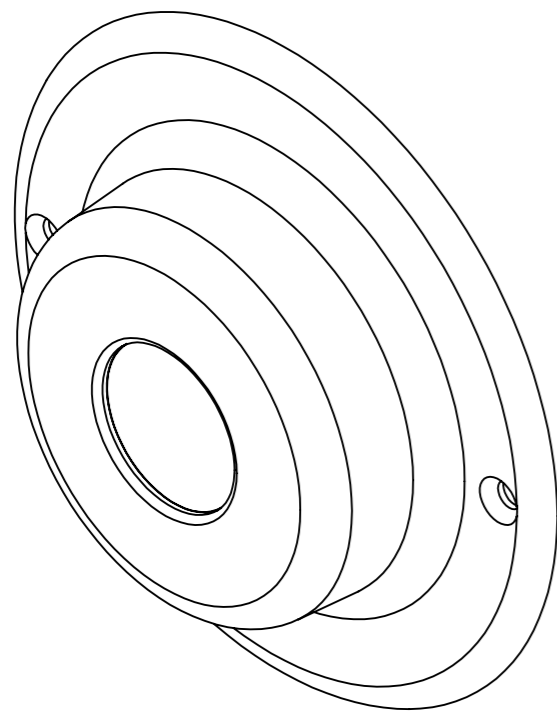

UNLESS OTHERWISE SPECIFIED: DIMENSIONS ARE IN MILLIMETERS SURFACE FINISH: TOLERANCES: LINEAR: ANGULAR:				FINISH: Polished		DEBUR AND BREAK SHARP EDGES		DO NOT SCALE DRAWING		REVISION	
								Blackbox-av		01639 767007	
DRAWN				NAME		SIGNATURE		DATE		TITLE:	
David Knight				DJK		20-2-16				Single Cup Magnetic Hanger	
CHK'D											
APPV'D											
MFG											
Q.A								MATERIAL:		DWG NO.	
								Black Accetal		single-cup-magnetic-hanger	
								WEIGHT:		SCALE:1:1	
										SHEET 1 OF 1	
										A3	