

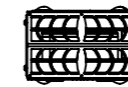

UNLESS OTHERWISE SPECIFIED: DIMENSIONS ARE IN MILLIMETERS SURFACE FINISH: TOLERANCES: LINEAR: ANGULAR:				FINISH: Light Oak Stain		DEBUR AND BREAK SHARP EDGES		DO NOT SCALE DRAWING		REVISION	
								Blackbox-av		01639 767007	
DRAWN				NAME		SIGNATURE		DATE		TITLE:	
David Knight				David Knight		DJK		28-8-15		Solar Audio Post - Accoya - Plinth	
CH'K'D											
APP'V'D											
MFG											
Q.A								MATERIAL:		DWG NO.	
								Various		Accoya Solar Post Pinth	
								WEIGHT:		SCALE:1:10	
										SHEET 1 OF 1	
										A3	

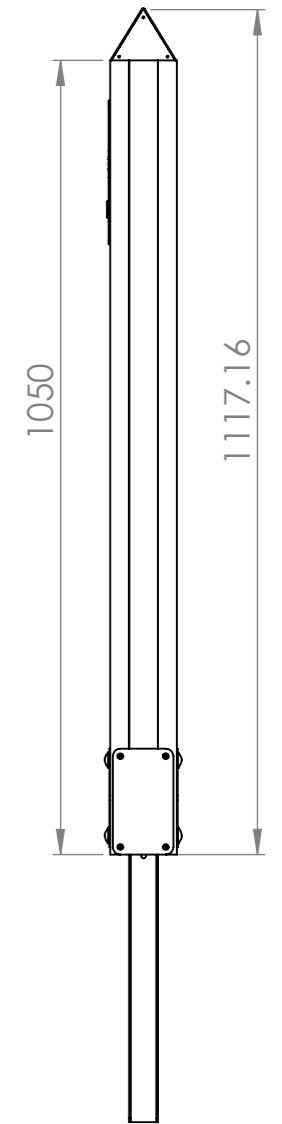

UNLESS OTHERWISE SPECIFIED: DIMENSIONS ARE IN MILLIMETERS SURFACE FINISH: TOLERANCES: LINEAR: ANGULAR:				FINISH: <b>Internal Part</b>		DEBUR AND BREAK SHARP EDGES		DO NOT SCALE DRAWING		REVISION	
								<b>Blackbox-av</b>		<b>01639 767007</b>	
DRAWN <b>David Knight</b>				SIGNATURE <b>DJK</b>		DATE <b>3-3-16</b>		TITLE: <b>Audio Bench Back</b>			
CHK'D											
APPV'D											
MFG											
Q.A						MATERIAL: <b>1.2 SS 316</b>		DWG NO. <b>Accoya Solar Post In-Ground</b>		A3	
						WEIGHT:		SCALE:1:10		SHEET 1 OF 1	

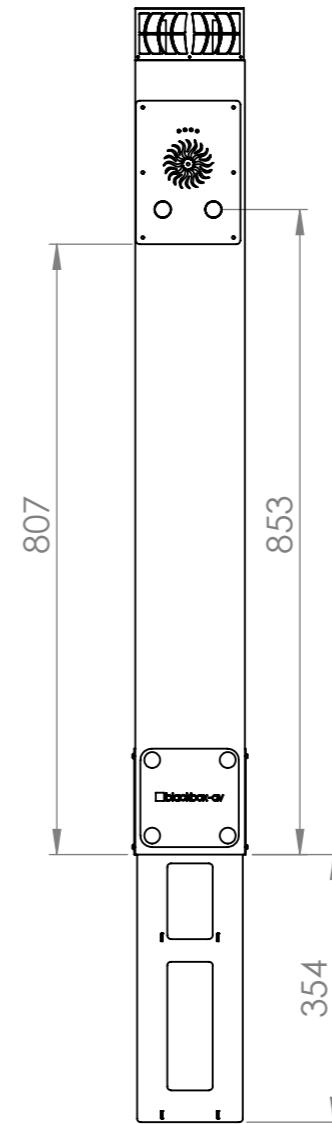
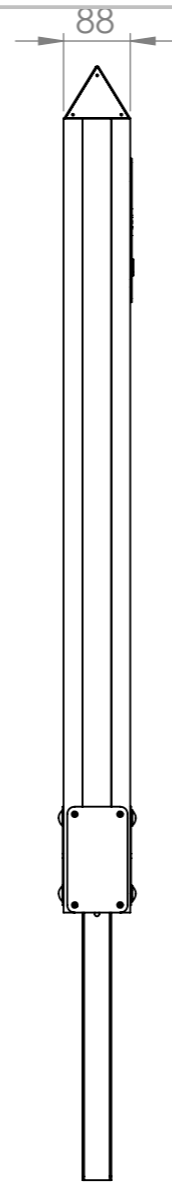
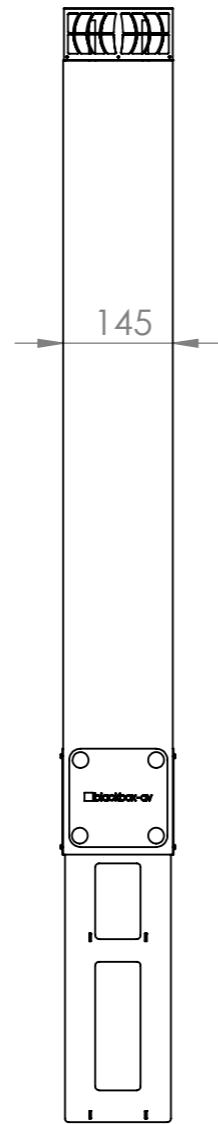
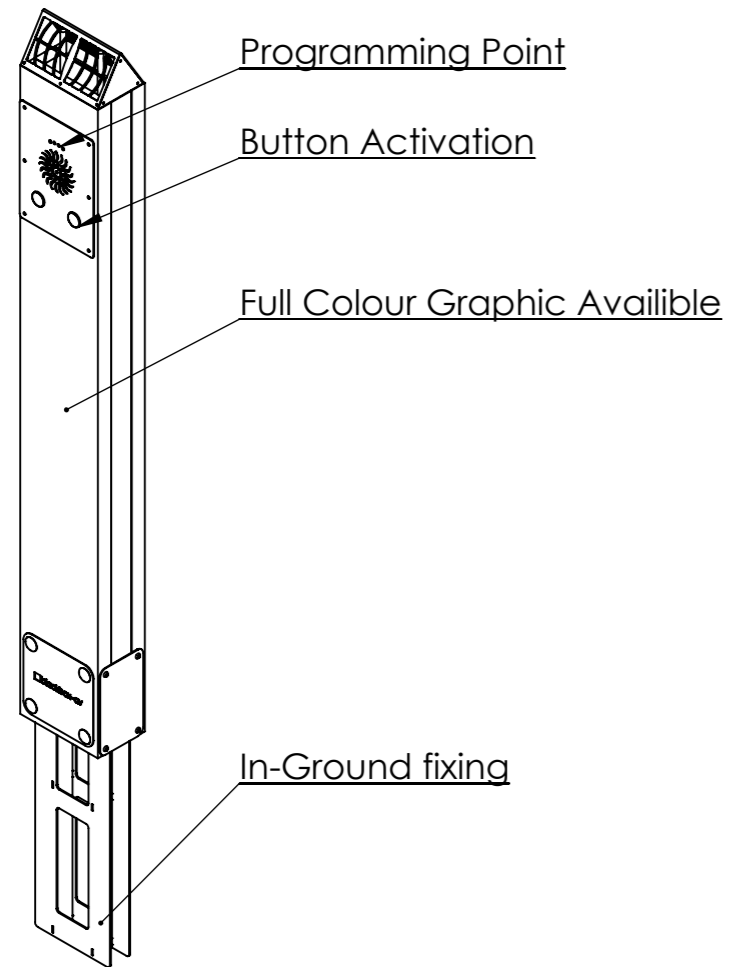
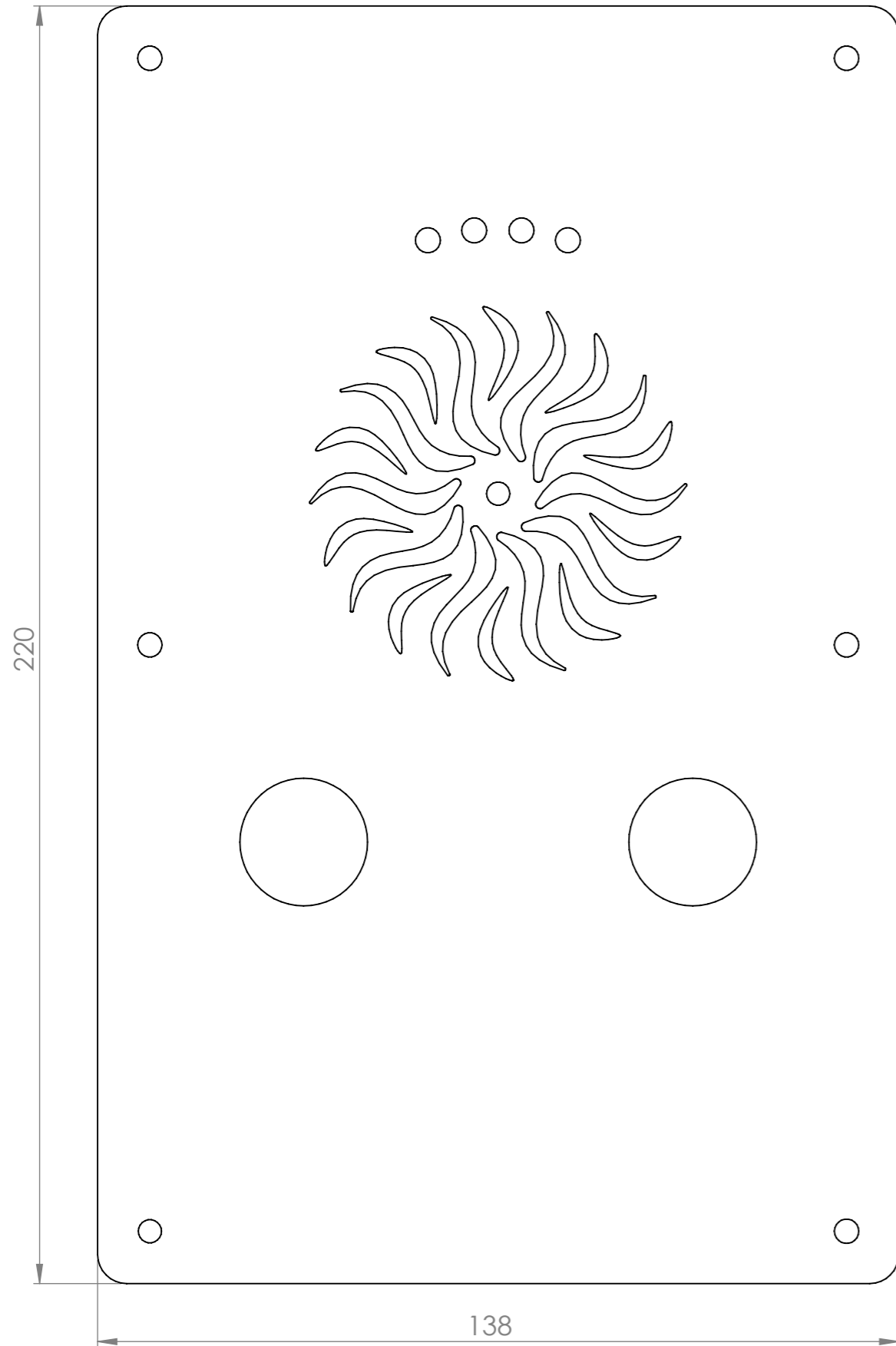

				+44(0) 1639 767 007 www.blackboxav.co.uk sales@blackboxav.co.uk		DO NOT SCALE DRAWING		REVISION	
UNLESS OTHERWISE SPECIFIED: DIMENSIONS ARE IN MILLIMETERS  The information, text and related graphics published in this document are the sole property of blackbox-av and are intended for the recipient only.				FINISH:  <b>Brushed SS</b>		DEBUR AND BREAK SHARP EDGES		TITLE:  <b>Solar Post Front Plate v2</b>	
DRAWN		NAME		SIGNATURE		DATE		MATERIAL:	
CHK'D		David Knight		DKNIGHT		29-1-18		316 Brushed Stainless Steel	
				WEIGHT:		SCALE:1:1		SHEET 1 OF 1	
						DWG NO.:		A3	
						2 BUTTON LARGER FACE PLATE W SUN SPEAKER v1			

