



# SoundClip-2

## Manual

## Contents

Safety Guide.....	3
Your new SC-2.....	4
Setting Up.....	5
Overview .....	5
Connections .....	6
Programming Content .....	7
Configuration Modes .....	8
Delay .....	10
Master Volume.....	10
Status LED.....	10
Trigger and Buttons.....	10
Unique AutoPlay functionality .....	11
GPIO Connection.....	11
Troubleshooting.....	11
Technical Information .....	12
Technical Drawings .....	12

## Safety Guide

Please observe the following when installing this device.

### Warning

- This product is not designed to be resistant to moisture or excessive dirt/dust. When deciding on a suitable installation point ensure there is reasonable protection from environmental damage.
- If you require this unit to be installed outdoors or in a dusty or damp environment use a certified IP rated enclosure and seal any entry/exit holes of wiring etc. If the unit needs to be periodically updated you will need to select an enclosure with an easy to remove lid and gasket seal. This product should not exceed its operating temperature
- If there is damage to the power supply in any way, arrange for a replacement unit by contacting blackbox-av. They may require you to send the defective power unit back so in this case do not dispose of the power supply unless prompted to do so. If you wish to source your own power supply a CE or FC certified double insulated and regulated supply is required. The SoundClip has an output rating of 12vDC at 2A, 24W. Using a power supply with a higher voltage will irreparably damage the SoundClip unit.
- Do not place the unit in direct sunlight for prolonged periods as this may cause the product to overheat.
- Disposal of old electrical equipment please follow the guidelines associated with your country/territory or ship the unit back to blackbox-av and we will dispose/recycle the unit. The symbol on the left indicates that this product shall not be treated as household waste. Instead it shall be



handed to applicable collection point for the recycling of electronic equipment. If you dispose of this unit correctly you will be helping prevent future harm to the environment which is caused by poor waste management of this type of equipment.

### Precautions of Use

- Whilst the unit is connected to a mains outlet and the power is switched on it is providing energy for operating the device. If the unit is not being used for long periods of time it is recommended to turn off the power as it will prolong the life of its electronic circuitry.
- Do not operate the unit below -10 or above 50 degrees Celsius. Do not bring the unit from a very cold environment to a warm environment without allowing it time to acclimatise as condensation may affect its operation.
- When using different types of push buttons, PIR's and other hardware connected to the button inputs and GPIO connections make sure they are compatible with the device. Please see the technical spec page for details on these connections. Failure to use care with these connections may result in damaging the device and subsequently affect the blackbox-av warranty.
- When attaching headphones or speakers please use certified and good quality accessories. Failure to use care with these connections may result in damaging the device and subsequently affect the blackbox-av warranty

## Your new SC-2

### In the box

1. SoundClip-2 Unit
2. Micro SD Card to USB Reader
3. Micro SD Card
4. Precision Screwdriver
5. 12V Power Adapter
6. AC Plug (dependant on your country)
7. Terminal Blocks
8. User Manual

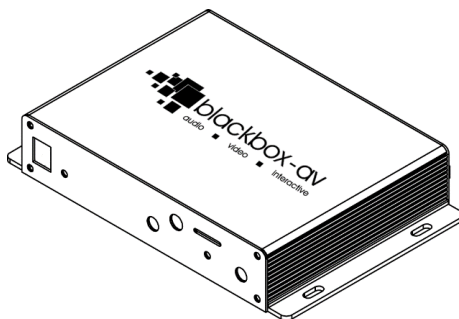

### SoundClip-2

The SoundClip-2 is the first in our range of compact, stand-alone, high quality stereo audio players. It can be used to present audio through headphones via two 3.5mm audio jacks or 2 speakers via wired terminal.

### Power Adapter

Connect your supplied 12V DC adapter to the '12V DC in' to give power to the device. Once turned on, the 'ON/OFF' LED will light up.

### Micro SD Card Reader

The media player is compatible with most MicroSD cards – capacity up to 32GB



## Setting Up

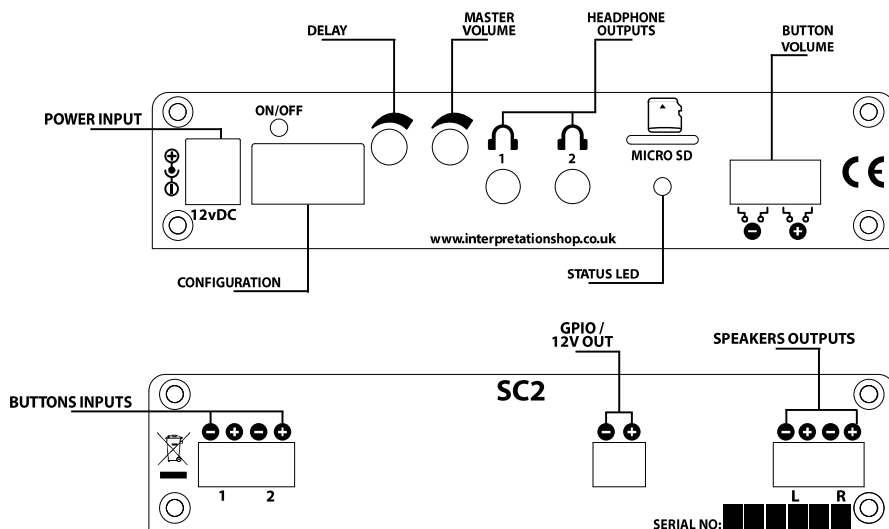

## Overview

### Button Inputs

The SoundClip-2 can accept up to two buttons / triggers.

### Headphone Output

This device has 2 x stereo high-quality 3.5mm jack outputs.

### Master Volume

Adjustable in order to dictate the maximum volume available to users.

### Delay

Set the duration of your delay time.

### Speaker Outputs

The onboard amplifier has 2 x 3w into 4Ω speakers. These can be connected to various speakers.

### GPIO Out

This GPIO is switched on during audio playback. It can be used to power LED's.

### Status LED

The green LED indicates the player state.

### Button Volume

Dedicated volume terminals allow users the ability to increase or decrease the volume.

## Connections

The SoundClip supports the following connections:

### Headphones

Up to 2 headphones can be connected through the 3.5mm jacks. Simply connect via the headphone 1 and 2 output.

### AutoPlay Headphones / Devices

The SoundClip range supports our AutoPlay Headphones. For connection instructions please refer to the individual headphone manuals.

### Speakers

Wire speakers to the 'Speaker Left' and 'Speaker Right' terminal blocks. Follow the '+' and '-' directions as appropriate and insert wires by screwing into place with the supplied screwdriver.

### Activation Buttons

To utilise button activation you must wire buttons to the designated terminals. Insert the wire ends into the terminal and screw into place using the provided screwdriver.

### Volume Buttons

Connect 2 buttons to the designated terminal. To do this simply insert the wire ends and screw in place with the supplied screwdriver.

### Lighting

To use lighting with the SoundClip you must wire them to the labelled 'GPIO / 12V Out' terminal. As standard the lights will be activated when content is playing and deactivated when content stops.

### PIR

To utilise a PIR trigger, you must wire the trigger cable and ground wire into the button 1 terminal, with the power connection wired into the GPIO 12V out terminal. Follow the colour coded steps below:

Connect the terminal with the red wire attached to the GPIO Out

Connect the terminal with the blue and yellow wires attached to button 1 as per diagram below.

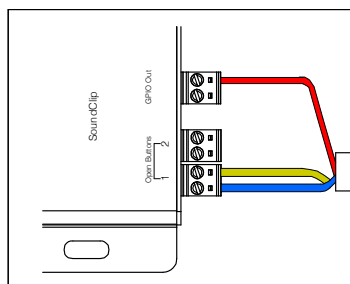

# Programming Content

Content for your SoundClip is stored on a MicroSD card (supplied pre-programmed). We suggest you use this as a template for uploading your own content.

*Should you need to use a different MicroSD Card we suggest you format the new card first to 'FAT' or 'FAT32'*

To Program your content you will need;

1. A PC or laptop with Windows OS
2. Audio Content in .mp3 format (supports up to 99 files)
3. MicroSD Card (supplied)
4. MicroSD to USB convertor (supplied)

## 1. Windows OS

Windows OS is required to program your SoundClip using a PC or Laptop (Xp – 10). MacOS is not supported due to hidden files generated by the OS.

## 2. Audio Content

The SoundClip can play up to 99 .mp3 tracks. These are stored in the root of the MicroSD Card. **You must number your files 001 – 099.**

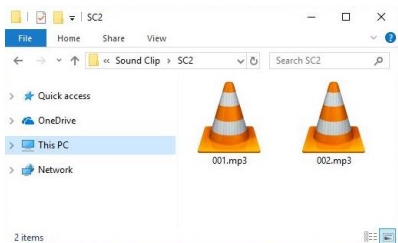

The order in which your files are played and the buttons they are assigned to is dependant on their name.

File 001 – Button 1 (or PIR trigger) / 1<sup>st</sup> file played  
File 002 – Button 2 / 2<sup>nd</sup> file played

## 3. Add Content

Once you have your audio files ready and correctly named, you simply need to load them all to the supplied MicroSD card.

Insert the MicroSD card into supplied MicroSD – USB card reader. Plug into a spare USB socket on your PC and open the folder.

Now simply drag and drop all the required files onto the MicroSD card. Insert the MicroSD card into your SoundClip and power on.

## Configuration Modes

Deciding how the SoundClip-2 is configured is completed using the 'Configuration Switches', this determines such things as whether it's looping, button activated or has a delay between content. Here are the mode options.

You must power on / off your SoundClip after changing modes. Some modes have an adjustable delay. For more information see the Delay section on page 11. Modes that are not compatible with the connection of volume buttons. If so it will be stated. The drawings below demonstrate each mode. If the switch is red it means its set to up; whilst green means set to down.

### Mode 0 – Interruptible Playback

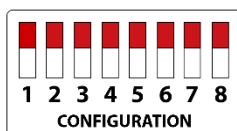

Up to 2 buttons can be connected. An individual MP3 can be assigned to each button and playback is interruptible in this mode, so pressing a button will active new playback.

- Button 1 – Track 1
- Button 2 – Track 2

### Mode 1 – Non-Interruptible Playback

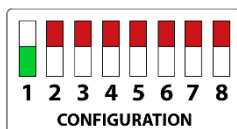

Up to 2 buttons can be connected. An individual MP3 can be assigned to each button and playback is non-interruptible. Playback must finish before your next selection.

- Button 1 – Track 1
- Button 2 – Track 2

### Mode 2 – Looping Playback

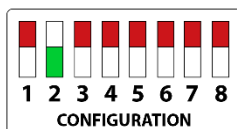

All content on the MicroSD card will continually play on a loop from power up. A delay can be set before the beginning of a new loop.

- Looping – Up to 99 tracks

### Mode 3 – PIR – Play All

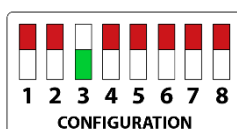

PIR triggered playback. All tracks will play once the PIR is triggered. A delay can be set once the tracks have played through. The PIR cannot trigger again during the delay.

- PIR – Up to 99 tracks



## Mode 4 – Next/Previous or PIR

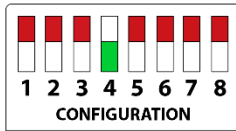

Users may navigate through tracks through button 1 for next and button 2 for previous. If connected to a PIR – it will play the next track each time its triggered. If inactive, a delay can be used to reset tracks back to the first.

- Button 1/PIR – Next track
- Button 2 – Previous track

## Mode 5 – AutoPlay

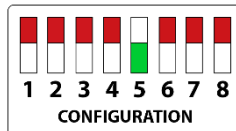

To be used with an AutoPlay Handset Track 1 will be played automatically upon pick up.

- AutoPlay Handset – Track 1
- Button 2 – Next track

---

## Mode 6 – Hold to Play

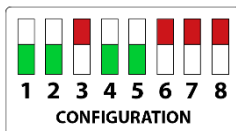

User must hold down the button to begin the track. Releasing will stop the track.

- Button 1 – Track 1
  - Button 2 – Track 2
-

## Delay

Following the ending of a track, the delay timer can be set to a maximum of 60 minutes and minimum of 5 seconds. Whilst the unit is in delay mode, the green status LED will flash. Modes 2, 3, and 4 can use delay.

## Master Volume

The Master Volume control is used to set the maximum volume level. If you do not use Volume Buttons this will be the volume set for all users.

However if you do use the dedicated Volume Button inputs, users will be able to increase / decrease the volume as they wish. In this case the Master Volume will set the maximum volume level users are able to reach with the Volume Buttons.

We suggest therefore when setting the Master Volume, you connect Volume Buttons and use the + button to increase the volume to the max, then adjust the Master Volume control accordingly.

The SoundClip will remain at the volume last set using the Volume Buttons. It will not reset when powered down / on.

## Status LED

### Red – On / Off

The red LED will be lit when the unit is powered.

### Green – Status

The Green LED is lit when content is being played. It will also flicker on / off in 1 second intervals when the unit is in 'Delay Mode'.

## Trigger and Buttons

### Connecting Buttons

Buttons are simply wired directly to the screw terminals at each of the two inputs. Pushbuttons work as standard with the player and are required to be the normally open 'push to close' type.

Piezo, vandal and water-resistant buttons can be purchased from our online shop if your installation requires a more robust switch

### Other Triggers

Other triggers can be connected such as a PIR or floor mat switch. If you want to attach different hardware to the SoundClip, you need to ensure the device is compatible or uses optical or mechanical relays to isolate its circuitry.

The inputs are 5.5V maximum.

## Unique AutoPlay functionality

The SoundClip has been specifically designed to work with our AutoPlay range of handsets and headphones. These give the unique functionality of being able to lift the headphone or handset to automatically trigger your content. See the manual for your specific handset / headphone for in-depth connection instructions

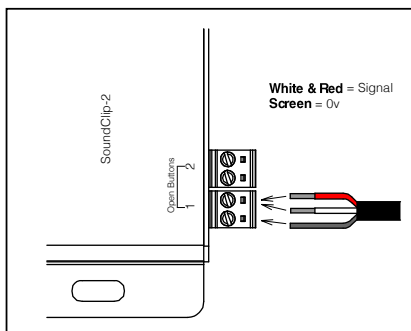

The drawing above demonstrates the wiring of one of our AutoPlay devices to a SoundClip-2 unit.

## GPIO Connection

The GPIO port can be used to connect power to other circuitry such as a sensor, LED's or a sensor such as PIR.

## Troubleshooting

If you have any trouble with the SoundClip unit, make sure your program files are correctly formatted. Performing an on / off reset may also resolve issues.

If you require further assistance contact us at [support@blackboxav.co.uk](mailto:support@blackboxav.co.uk)

## Technical Information

<b>Weight</b>	0.75Kg
<b>Unpackaged Weight</b>	0.6Kg
<b>Dimensions</b>	110 x 155 x 28mm
<b>Message Storage Medium</b>	MicroSD Card (32GB of Storage)
<b>Maximum Number of Audio Files</b>	99 Files (mode dependant)
<b>Number of Buttons/Trigger Inputs</b>	2
<b>Message Encoding Format</b>	.MP3
<b>Speaker Audio Output</b>	2 x 3W RMS into 4Ω Speakers (Stereo)
<b>Frequency Response</b>	30Hz - 22KHz
<b>Headphone Audio Output</b>	2 x 3.5mm audio jack (headphones / handsets etc.)
<b>Speaker Output</b>	Screw terminals (phoenix)
<b>12V Out</b>	Power accessories such as low power LED's or PIR Sensors
<b>Power Supply</b>	External 12V 2A
<b>Power Consumption</b>	1.5W with Headphones, 7.5W with Speakers
<b>Common Switch Output</b>	Open Drain 50V

## Technical Drawings

*Drawings not to scale*

